

1500/1 Art. 1498

- D** **Gebrauchsanweisung**  
Accu-Pumpe
- 
- GB** **Operating Instructions**  
Battery Pump
- 
- F** **Mode d'emploi**  
Pompe sur accu
- 
- NL** **Gebruiksaanwijzing**  
Accupomp
- 
- S** **Bruksanvisning**  
Batteridriven pump
- 
- I** **Istruzioni per l'uso**  
Pompa a batteria
- 
- E** **Manual de instrucciones**  
Bomba con acumulador
- 
- P** **Instruções de utilização**  
Bomba com acumulador
- 
- DK** **Brugsanvisning**  
Akku-pumpe

# GARDENA Battery Pump 1500/1

Welcome to the Garden of GARDENA ...



Please read the Instructions for Use carefully and follow the instructions contained in them. Get to know the battery pump, its correct use and the safety instructions with the assistance of these Instructions for Use.



For safety reasons, children and young persons under the age of 16 and people who have not read these Instructions for Use should not use this battery pump.

## Intended use

→ Please keep these instructions in a safe place.

1. Area of Application of Your GARDENA Battery Pump . . . . .	9
2. For Your Safety . . . . .	9
3. Initial Operation . . . . .	10
4. Operating . . . . .	11
5. Maintenance . . . . .	12
6. Trouble-Shooting . . . . .	13
7. After Operation . . . . .	13
8. Technical Data . . . . .	14
9. Service . . . . .	14

## 1. Area of Application of Your GARDENA Battery Pump

### Purpose

The GARDENA battery pump is intended for private use in domestic gardens and allotments. It is intended for drawing rainwater (or clear sweet water) out of rainwater butts e.g. the GARDENA rainwater butt.

The battery pump is ideal for the operation of a sprayer, for emptying rain barrels and paddling pools and for filling a watering can easily.

The pump can withstand complete submersion (watertight encapsulation) and is submerged in the water (max. submersion depth 1.5 m).

### Please note



**The pump should not be used for the delivery of salt water, muddy water, corrosive, easily inflammable or explosive liquids (e. g. petrol, paraffin, thinners), oil, heating oil or food-stuffs.**

**The water temperature should not exceed 35 °C.**

**Attention! For risks of injury the Accu must not be used as power source for other devices.**

**The battery pump may only be operated with the battery supplied.**

## 2. For Your Safety

→ Please comply with the safety instructions on the battery!



**Warning!**  
**Short-circuit – risk of fire**

→ Do not bridge contacts with metal components.

**Battery Safety****Danger of fire!**

- Never charge the battery near to acids and easily inflammable materials.

**Danger of Explosion!**

- Never throw a worn out battery on to an open fire.

**The battery is not watertight, but can remain suspended on the rainwater butt in rain.**

The battery connection line may not be used for attaching or transporting the pump. The pump can be submerged or raised via the telescopic pipe. Alternatively, a rope can be attached to the carrying handle to submerge, raise and secure the battery pump.

The battery may only be charged using the NL12 charger supplied as only the latter guarantees optimum technical harmonisation between the battery and the charger. Using other chargers may result in injury to persons/ damage to property. The use of other chargers will result in loss of all claims for liability and warranty claims against the manufacturer.

Never charge the Accu after having been heated up by operation or sun.

- Let it cool down first.

Never expose the Accu to direct sunlight while charging.

- Always detach the battery from the pump to charge it.

Fully discharging the battery can destroy it.

- Charge low battery immediately.

Only use the battery for the battery pump.

Under extreme conditions some accu acid could escape. This, however, does not represent a defect. Proceed as follows should the casing leak:

1. Immediately wash the affected area of the skin with soap and water.
2. Neutralize the accu acid with vinegar or lemon juice.
3. If accu acid should get into your eyes, rinse your eyes for at least 10 minutes with fresh water. Then contact your doctor immediately!

**Inspection**

Always inspect the battery pump (especially the connection line) before using it.

A damaged pump may not be used. If damaged, it is essential to have the pump checked by GARDENA Service.

**Safety Instructions****Dry-running destroys the pump!**

- Switch the pump off immediately the conveyed fluid runs out (turn knob to "0").

- Comply with the minimum depth of water stipulated in the specification for the pump.

Do not allow the pump to run with the output side closed.

**Electronic Circuit-Breaker**

If overloaded, the pump is switched off by the electronic protective switch in the Accu. The motor starts again automatically when it has cooled down (see **6. Trouble-Shooting**).

**Automatic Venting**

The pump is fitted with a vent valve.

The purpose of this vent valve is to remove any cushion of air present in the pump.

### 3. Initial Operation

We recommend using a GARDENA hose connection:

**Art. (2)915/2025** for 13 mm (1/2"), **Art. (2)916/2026** for 16 mm (5/8") and **Art. 2817** for 19 mm (3/4") for connecting a garden hose.

The 1/2" hose should not be more than 20 m long.

A relatively higher water pressure (greater spraying power) is to be expected from the watering equipment when 19 mm (3/4") hose connections are used because the friction losses in the hose are lower.

### Setting up the telescopic pipe on the container:

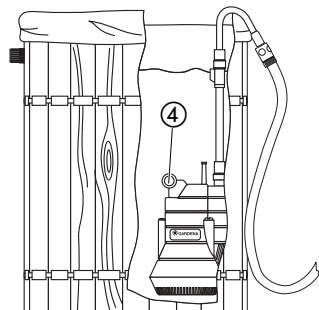

1. Screw telescopic pipe ① on the pump.
2. Release clamping sleeve ② of the telescopic pipe.
3. Adjust telescopic pipe stalk ③ to the height of the container. *The length of the telescopic pipe can be adjusted between 39–62 cm.*
4. Tighten clamping sleeve ② by hand.

The length of the telescopic pipe ③ should be set in such a way that the pump does not touch the bottom of the container. This prevents dirt in the container reaching the pump.

A rope must be run through the handle ④ of the pump for deeper water containers (max. 1.5 m).

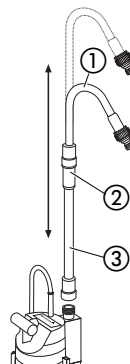

GB

### Complete Solution:

- (a) the GARDENA Rain Water Collection Filter (Art. No. 3820 / 3821)
- (b) the GARDENA Connecting Set (Art. No. 3815),
- (c) the GARDENA Rain Water Tank (Art. No. 3801 / 3805)
- (d) the matching GARDENA Cover for Rain Water Tank (Art. No. 3800 / 3804), and
- (e) the GARDENA Battery Pump (Art. No. 1498).

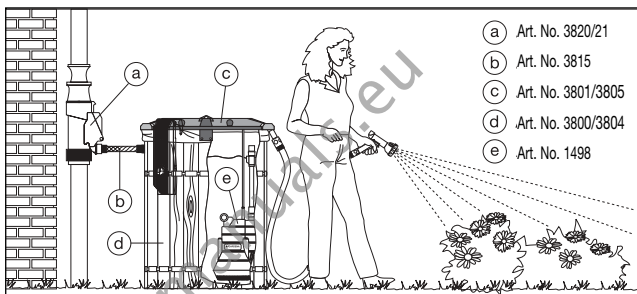

- (a) Art. No. 3820/21
- (b) Art. No. 3815
- (c) Art. No. 3801/3805
- (d) Art. No. 3800/3804
- (e) Art. No. 1498

### Use in shallow vessels:

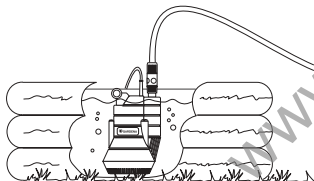

If the battery pump is used in flat containers, e.g. to empty a paddling pool, the telescopic pipe can be removed and replaced by the threaded tap connector supplied. The 13 mm (1/2"), 16 mm (5/8") or 19 mm (3/4") hose connection must be set up using Original GARDENA System hose connections.

## 4. Operating

### Charging the battery:

The battery may only be charged using the NL-12 charger supplied or the solar panel, Art. 7851-00.620.00 with charging cable Art. 1498-20.600.22, obtainable from GARDENA Service. Operating the pump is not possible during charging!

The battery is partially charged in the works for safety reasons. The battery must be charged before it is used for the first time. As this NiCd-battery is subject to self-discharging, the battery must be charged up to reach a full charge if it has been stored for a relatively long time.

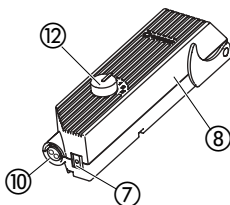
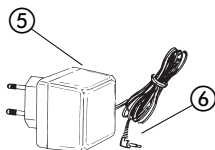

### Pumping water out of the container:

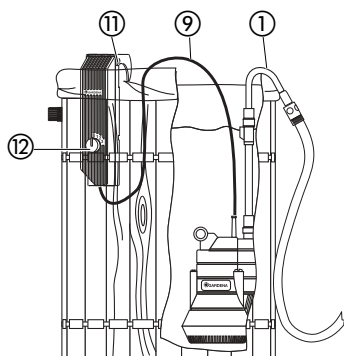

The outer surface and the contacts of the battery must be clean and dry before the charger is connected.

1. Plug charger ⑤ into a socket (230 V AC).
2. Plug equipment plug ⑥ into the charging socket ⑦ of the battery ⑧.  
*The charging process commences.*
3. Disconnect equipment plug ⑥ from the charged battery and unplug the charger ⑤.

Charging time approx. 24 hours for the initial charge.

Afterwards, 12 - 24 hours depending on the state of charge.

The Accu reaches its full capacity only after numerous (approx. 5) charging/discharging processes.

1. Plug connection cable ⑨ of the pump into the connection socket ⑩ of the charged battery.
2. Suspend pump with telescopic pipe ① in the container.
3. Hang the battery on the outside of the container using the battery clip ⑪ –or– fix it outside, protected from falling into the container (e.g. on the wall).
4. Turn knob ⑫ on the battery to **1 to 3** depending on requirements. *The pump conveys the water.*

	Recommended purpose	Max. quantity conveyed / battery charge	Max. life of battery charge
<b>Stage 0</b> : off	-	-	-
<b>Stage 1</b> : low	e.g. pump out paddling pool	400 l *	60 min.
<b>Stage 2</b> : mittel	e.g. spraying	330 l *	40 min.
<b>Stage 3</b> : high	e.g. clean garden equipment	220 l *	20 min.

\*Value was determined with 20 m (1/2") hose with GARDENA sprayer Art.1906.

**The battery heats up during pumping. This is normal and does not impair its performance.**

## 5. Maintenance

### Cleaning the filter:

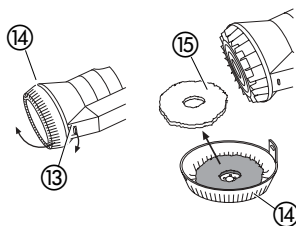

### Cleaning the battery:

The GARDENA battery pump works largely without maintenance. If conveying dirty rainwater, the filter must be cleaned regularly.

**The pump must not be used without a filter!**

1. Release catch ⑬ manually from the housing and remove the suction foot ⑭.
2. Clean filter ⑮ under flowing water.
3. Insert filter ⑮ in the suction foot ⑭ again and push the suction foot on to the pump.

**Never clean the battery under running water!**

➔ If the battery is dirty, clean it with a soft, dry cloth.

## 6. Trouble-Shooting

Fault	Possible cause	Remedy
<b>Pump running but does not deliver.</b>	Air cannot escape because the pressure line is closed. Possible kink in the pressure hose.	→ Open the pressure line (e. g. shut-off valve, delivery units).
	Air in suction foot.	Wait for about max. 60 seconds until the pump has vented; if necessary, turn off and then on again.
	Suction foot / filter blocked.	→ Clean filter (see <b>5. Maintenance</b> ).
	Water level below minimum water level when starting the pump.	→ Submerge pump deeper. Minimum water depth of water is 5.5 cm.
<b>Pump does not start, or stops suddenly during operation.</b>	Electronic protective switch in the Accu has switched off the pump.	→ Clean filter (see <b>5. Maintenance</b> ). Comply with the maximum temperature for media conveyed (35 °C).
	Power connection interrupted.	→ Check connection cable and electrical plug and socket connections.
<b>Pump is running but the delivery output drops suddenly.</b>	Suction foot / filter blocked.	→ Clean the filter (see <b>5. Maintenance</b> ).
	Battery flat.	→ Charge the battery (see <b>4. Operating</b> ).

**Attention! The threaded connection for the pump housing is locked. Work on the electrical section of the pump may only be performed by GARDENA Service.**

If you have any other problem, please contact our Customer Service.

## 7. After Operation

**Preparing the battery pump for storage:**

**To prevent misuse and accidents, the battery must always be stored disconnected from the pump.**

1. Take battery pump out of the container and unplug.
2. Charge battery (see **4. Operating**)
3. Store battery and pump in a dry, frost proof location, out of the reach of children.

The battery must be stored charged to increase the life of the battery.

**Disposing of the battery:**



These Accus contain nickel /cadmium cells. After their lifetime have expired, they may not be disposed of as normal house rubbish, but must be disposed of properly.

- Return batteries to the dealer – **or** – send the batteries direct to one of the service centres listed overleaf.

## 8. Technical Data

Article	Pump	Accu
Rated power	60 W	
Max. quantity conveyed	1500 l/min (stage 2)	
Max. pressure / delivery head	1.1 bar / 11 m (stage 2)	
Max. submersion depth	1.5 m	
Minimum water depth for operation	ca. 5.5 cm	
Weight	1.3 kg (without telescopic pipe)	0.8 kg
Max. water temperature	35 °C	
Voltage / frequency		12 V (NiCd) / 1.8 Ah
Number of possible charges		Max. 1000 times

## 9. Service

### Warranty

GARDENA guarantees this product for 2 years (from date of purchase).

This guarantee covers all serious defects of the unit that can be proved to be material or manufacturing faults. Under warranty we will either replace the unit or repair it free of charge if the following conditions apply:

- The unit must have been handled properly and in keeping with the requirements of the operating instructions.
- Neither the purchaser or a non-authorised third party have attempted to repair the unit.

The impeller is a wearing part and is not covered by the warranty.

This manufacturer's guarantee does not affect the user's existing warranty claims against the dealer/seller.

If a fault occurs with your Garden Pump, please return the faulty unit together with a copy of the receipt and a description of the fault, with postage paid to one of the GARDENA Service Centres listed on the back of these operating instructions.

<p><b>D</b> <i>Produkthftung</i></p>	<p>Wir weisen ausdrücklich darauf hin, dass wir nach dem Produkthftungs-gesetz nicht für durch unsere Geräte hervorgerufene Schäden einzustehen haben, sofern diese durch unsachgemäße Reparatur verursacht oder bei einem Teileaustausch nicht unsere originale GARDENA Teile oder von uns freigegebene Teile verwendet wurden und die Reparatur nicht vom GARDENA Service oder dem autorisierten Fachmann durchgeführt wird. Entsprechendes gilt für Ergänzungsteile und Zubehör.</p>
<p><b>GB</b> <i>Product Liability</i></p>	<p>We expressly point out that, in accordance with the product liability law, we are not liable for any damage caused by our units if it is due to improper repair or if parts exchanged are not original GARDENA parts or parts approved by us, and, if the repairs were not carried out by a GARDENA Service Centre or an authorised specialist. The same applies to spare parts and accessories.</p>
<p><b>F</b> <i>Responsabilité</i></p>	<p>Nous vous signalons expressément que GARDENA n'est pas respon-sable des dommages causés par ses appareils, dans la mesure où ces dommages seraient causés suite à une réparation non conforme, dans la mesure où, lors d'un échange de pièces, les pièces d'origine GARDENA n'auraient pas été utilisées, ou si la réparation n'a pas été effectuée par le Service Après-Vente GARDENA ou l'un des Centres SAV agréés GARDENA. Ceci est également valable pour tout ajout de pièces et d'accessoires autres que ceux préconisés par GARDENA.</p>
<p><b>NL</b> <i>Productaansprakelijkheid</i></p>	<p>Wij wijzen er nadrukkelijk op, dat wij op grond van de wet aansprakelijk-heid voor producten niet aansprakelijk zijn voor schade ontstaan door onze apparaten, indien deze door onvakkundige reparatie veroorzaakt zijn, of er bij het uitwisselen van onderdelen geen gebruik gemaakt werd van onze originele GARDENA onderdelen of door ons vrijgegeven onderdelen en de reparatie niet door de GARDENA technische dienst of de bevoegde vak-man uitgevoerd werd. Ditzelfde geldt voor extra-onderdelen en accessoires.</p>
<p><b>S</b> <i>Produktansvar</i></p>	<p>Tillverkaren är inte ansvarig för skada som orsakats av produkten om skadan beror på att produkten har reparerats felaktigt eller om, vid repara-tion eller utbyte, andra än Original GARDENA reservdelar har använts. Samma sak gäller för kompletteringsdelar och tillbehör.</p>
<p><b>I</b> <i>Responsabilità del prodotto</i></p>	<p>Si rende espressamente noto che, conformemente alla legislazione sulla responsabilità del prodotto, non si risponde di danni causati da nostri arti-coli se originati da riparazioni eseguite non correttamente o da sostituzioni di parti effettuate con materiale non originale GARDENA o comunque da noi non approvato e, in ogni caso, qualora l'intervento non venga eseguito da un centro assistenza GARDENA o da personale specializzato autoriz-zato. Lo stesso vale per le parti complementari e gli accessori.</p>
<p><b>E</b> <i>Responsabilidad de productos</i></p>	<p>Advertimos que conforme a la ley de responsabilidad de productos no nos responsabilizamos de daños causados por nuestros aparatos, siempre y cuando dichos daños hayan sido originados por arreglos o reparaciones indebidas, por recambios con piezas que no sean piezas originales GARDENA o bien piezas no autorizadas por nosotros, así como en aquellos casos en que la reparación no haya sido efectuada por un Servicio Téc-nico GARDENA o por un técnico autorizado. Lo mismo es aplicable para las piezas complementarias y accesorios.</p>
<p><b>P</b> <i>Responsabilidade sobre o produto</i></p>	<p>Queremos salientar que segundo a lei da responsabilidade do fabricante, nós não nos responsabilizaremos por danos causados pelo nosso equipa-mento, quando estes ocorrerem em decorrência de reparações inadequadas ou da substituição de peças por peças não originais da GARDENA, ou pe-ças não autorizadas. A responsabilidade tornar-se-à nula também depois de reparações realizadas por oficinas não autorizadas pela GARDENA. Esta restrição valerá também para peças adicionais e acessórios.</p>
<p><b>DK</b> <i>Produktansvar</i></p>	<p>Vi gør udtrykkeligt opmærksom på at i henhold til produktansvarsloven er vi ikke ansvarlige for skader forårsaget af vores udstyr, hvis det er på grund af uautoriserede reparationer eller hvis dele er skiftet ud og der ikke er anvendt originale GARDENA dele eller dele godkendt af os, eller hvis reparationerne ikke er udført af GARDENA-service eller en autoriseret fagmand. Det samme gælder for ekstra udstyr og tilbehør.</p>



<p><b>D EU-Konformitätserklärung</b>  <b>Maschinenverordnung (9. GSGVO) / EMVG / Niedersp. RL</b>  Der Unterzeichnete GARDENA Kress + Kastner GmbH · Hans-Lorenser-Straße 40 · D-89079 Ulm bestätigt, dass die nachfolgend bezeichneten Geräte in der von uns in Verkehr gebrachten Ausführung die Anforderungen der harmonisierten EU-Richtlinien, EU-Sicherheitsstandards und produktspezifischen Standards erfüllen. Bei einer nicht mit uns abgestimmten Änderung der Geräte verliert diese Erklärung ihre Gültigkeit.</p>	Bezeichnung des Gerätes: Accu-Pumpe Description of the unit: Battery Pump Désignation du matériel : Pompe sur accu Omschrijving van het apparaat: Accupomp Produktbeschreibung: Batteridreven pomp Descrizione del prodotto: Pompa a batteria Descripción de la mercancía: Bomba con acumulador Descrição do aparelho: Bomba com acumulador Beskrivelse af enhederne: Akku-pumpe
<p><b>GB EU Certificate of Conformity</b>  The undersigned GARDENA Kress + Kastner GmbH · Hans-Lorenser-Str. 40 · D-89079 Ulm hereby certifies that, when leaving our factory, the units indicated below are in accordance with the harmonised EU guidelines, EU standards of safety and product specific standards. This certificate becomes void if the units are modified without our approval.</p>	Typ: Art.-Nr.: Type: Art. No.: Type : Référence : Type: Art. nr.: Typ: 1500/1 Art. nr.: 1498 Modello: Art.: Tipo: Art. No.: Tipo: Art. No.: Type: Varenr.:
<p><b>F Certificat de conformité aux directives européennes</b>  Le constructeur, soussigné : GARDENA Kress + Kastner GmbH · Hans-Lorenser-Str. 40 · D-89079 Ulm déclare qu'à la sortie de ses usines le matériel neuf désigné ci-dessous était conforme aux prescriptions des directives européennes énoncées ci-après et conforme aux règles de sécurité et autres règles qui lui sont applicables dans le cadre de l'Union européenne. Toute modification portée sur ce produit sans l'accord express de GARDENA supprime la validité de ce certificat.</p>	EU-Richtlinien: EU directives: 98/37/EG Directives européennes : EU-richtlijnen: 89/336/EG EU direktiv: Direttive UE: 73/23/EG Normativa UE: Directrices da UE: 93/68/EG EU Retningslinier:
<p><b>NL EU-overeenstemmingsverklaring</b>  Ondergetekende GARDENA Kress + Kastner GmbH · Hans-Lorenser-Str. 40 · D-89079 Ulm bevestigt, dat de volgende genoemde apparaten in de door ons in de handel gebrachte uitvoering voldoen aan de eis van, en in overeenstemming zijn met de EU-richtlijnen, de EU-veiligheidsstandaard en de voor het product specifieke standaard. Bij een niet met ons afgestemde verandering aan de apparaten verliest deze verklaring haar geldigheid.</p>	
<p><b>S EU Tillverkarintyg</b>  Undertecknad firma GARDENA Kress + Kastner GmbH · Hans-Lorenser-Straße 40 · D-89079 Ulm intygar härmed att nedan nämnda produkter överensstämmer med EU:s direktiv, EU:s säkerhetsstandard och produktspecifikation. Detta intyg upphör att gälla om produkten ändras utan vårt tillstånd.</p>	
<p><b>I Dichiarazione di conformità alle norme UE</b>  La sottoscritta GARDENA Kress + Kastner GmbH · Hans-Lorenser-Str. 40 · D-89079 Ulm certifica che il prodotto qui di seguito indicato, nei modelli da noi commercializzati, è conforme alle direttive armonizzate UE nonché agli standard di sicurezza e agli standard specifici di prodotto. Qualunque modifica apportata al prodotto senza nostra specifica autorizzazione invalida la presente dichiarazione.</p>	Anbringningsjahr der CE-Kennzeichnung: Year of CE marking: Date d'apposition du marquage CE : Installatiejaar van de CE-aanduiding: 2003 CE-Mærkningsår: Anno di rilascio della certificazione CE: Colocación del distintivo CE: Ano de marcação pela CE: CE-Mærkningsår:
<p><b>E Declaración de conformidad de la UE</b>  El que suscribe GARDENA Kress + Kastner GmbH · Hans-Lorenser-Str. 40 · D-89079 Ulm declara que la presente mercancía, objeto de la presente declaración, cumple con todas las normas de la UE, en lo que a normas técnicas, de homologación y de seguridad se refiere. En caso de realizar cualquier modificación en la presente mercancía sin nuestra previa autorización, esta declaración pierde su validez.</p>	
<p><b>P Certificado de conformidade da UE</b>  Os abaixo mencionados GARDENA Kress + Kastner GmbH · Hans-Lorenser-Str. 40 · D-89079 Ulm Por este meio certificam que ao sair da fábrica os aparelhos abaixo mencionados estão de acordo com as diretrizes harmonizadas da UE, padrões de segurança e de produtos específicos. Este certificado ficará nulo se as unidades forem modificadas sem a nossa aprovação.</p>	 Thomas Heini Technische Leitung Technical Dept. Manager Direction technique Hoofd technische dienst Technical Director Direzione Tecnica Dirección Técnica Director Técnico Teknisk direktør
<p><b>DK EU Overensstemmelse certificat</b>  Undertegnede GARDENA Kress + Kastner GmbH · Hans-Lorenser-Str. 40 · D-89079 Ulm bekræfter hermed, at enheder listet herunder, ved afsendelse fra fabrikken, er i overensstemmelse med harmoniserede EU retningslinier, EU sikkerheds standarder og produkt specifikations standarder. Dette certifikat træder ud af kraft hvis enhederne er ændret uden vor godkendelse.</p>	Ulm, den 11.06.2002 Ulm, 11.06.2002 Fait à Ulm, le 11.06.2002 Ulm, 11-06-2002 Ulm, 2002.06.11 Ulm, 11.06.2002 Ulm, 11.06.2002 Ulm, 11.06.2002 Ulm, 11.06.2002 Ulm, 11.06.2002

**Pumpen-Kennlinie:**

**Performance characteristics**

**Courbes de performance**

**Prestatiegrafiek**

**Kapacitetskurva**

**Curva di rendimento**

**Curva característica de la bomba**

**Características de performance**

**Ydelses karakteristika**

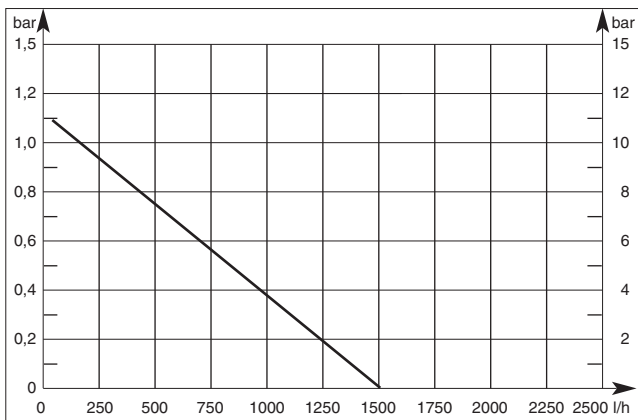

[www.devicemanuals.eu](http://www.devicemanuals.eu)

**Deutschland**

GARDENA Service  
Hans-Lorenser-Straße 40  
D-89079 Ulm  
Produktfragen: (0731) 490-123  
Reparaturen: (0731) 490-290

**Argentina**

Argensem S.A.  
Venezuela 1075  
(1618) El Talar - Buenos Aires

**Australia**

NYLEX Corporation Ltd.  
25-29 Nepean Highway  
P.O. Box 68  
Mentone, Victoria 3194

**Austria**

GARDENA Österreich Ges. m.b.H.  
Stettnerweg 11-15  
2100 Korneuburg

**Belgium**

MARKT (Belgium) NV/SA  
Sterrebeekstraat 163  
1930 Zaventem

**Brazil**

M. Cassab  
Av. das Nações Unidas, 20.882  
Santo Amaro, CEP 04795-000  
São Paulo - S.P.

**Bulgaria / България**

ДЕНЕКС ООД  
Бул. "Г.М.Димитров" 16 ет.4  
София 1797

**Canada**

GARDENA Canada Ltd.  
100, Summerlea Road  
Brampton, Ontario  
Canada L6T 4X3

**Chile**

Antonio Martinic Y CIA. LTDA.  
Gilberto Fuenzalida 185 Loc.  
Las Condes - Santiago de Chile

**Costa Rica**

Compania Exim  
Euroiberoamericana S.A.  
350 Sur del Automercado  
Los Yoses  
San Pedro

**Cyprus**

FARMOKIPIKI LTD  
P.O. Box 7098  
74, Digeni Akrita Ave.  
1641 Nicosia

**Czech Republic**

GARDENA spol. s.r.o.  
Řípská 20a, č.p. 1153  
62700 Brno

**Denmark**

GARDENA Danmark A/S  
Naverland 8  
2600 Glostrup

**Finland**

Habitec Oy  
Martinkyläntie 52  
01720 Vantaa

**France**

GARDENA France  
Service Après-Vente  
BP 50080  
95948 ROISSY CDG Cedex

**Great Britain**

GARDENA UK Ltd.  
27-28 Brenkley Way  
Bleazard Business Park  
Seaton Burn  
Newcastle upon Tyne NE13 6DS

**Greece**

Agrokip G. Psomadopoulos & Co.  
20, Lykourgou str.  
Kallithea - Athens

**Hungary**

GARDENA Magyarország Kft.  
Késmárk utca 22  
1158 Budapest

**Iceland**

Heimilistaeki hf  
Saetun 8  
P.O. Box 5340  
125 Reykjavik

**Republic of Ireland**

Michael McLoughlin & Sons  
Hardware Limited  
Long Mile Road  
Dublin 12

**Italy**

GARDENA Italia S.p.A.  
Via Donizetti 22  
20020 Lainate (MI)

**Japan**

KAKUDAI Mfg. Co. Ltd.  
1-4-4, Itachibori Nishi-ku  
Osaka 550

**Luxembourg**

Magasins Jules Neuberg  
Grand Rue 30  
Case Postale No. 12  
Luxembourg 2010

**Netherlands**

GARDENA Nederland B.V.  
Postbus 50176  
1305 AD ALMERE  
**Neth. Antilles**  
Jonka Enterprises N.V.  
Sta. Rosa Weg 196  
P.O. Box 8200  
Curaçao

**New Zealand**

NYLEX New Zealand Limited  
Private Bag 94001  
South Auckland Mail Centre  
10 Offenhauser Drive  
East Tamaki, Manukau

**Norway**

GARDENA Norge A/S  
Postboks 214  
2013 Skjetten

**Poland**

GARDENA Polska Sp. z o.o.  
Szymanów 9d  
05-532 Baniocza

**Portugal**

MARKT (Portugal), Lda.  
Recta da Granja do Marquês  
Edif. GARDENA  
Algueirão  
2725-596 Mem Martins

**Russia / Россия**

АО АМИДА ТТЦ  
ул. Мосфильмовская 66  
117330 Москва

**Singapore**

Variware  
Holland Road Shopping Centre  
227-A 1st Fl., Unit 29  
Holland Avenue  
Singapore 1027

**Slovenia / Croatia**

Silk d.o.o. Trgovina  
Brodišče 15  
1236 Trzin

**South Africa**

GARDENA South Africa (Pty.) Ltd.  
P.O. Box 11534  
Vorna Valley 1686

**Spain**

ANMI Andreu y Miriam S.A.  
Calle Pere IV, 111  
08018 Barcelona

**Sweden**

GARDENA Svenska AB  
Box 9003  
20039 Malmö

**Switzerland**

GARDENA Kress + Kastner AG  
Bitziberg 1  
8184 Bachenbülach

**Ukraine / Украина**

АОЗТ АЛЬЦЕСТ  
ул. Гайдара 50  
г. Киев 01033

**Turkey**

Dost Diş Ticaret Mümessilik A.Ş.  
Yeşilbağlar Mah. Başkent  
Cad. No. 26  
Pendik - İstanbul

**USA**

GARDENA  
3085 Shawnee Drive  
Winchester, VA 22604  
1498-01.960.01/0031  
© GARDENA Manufacturing GmbH  
D-89070 Ulm  
<http://www.gardena.com>